

Model 45 | CNC Machining Centers

3 Axis



THERMWOOD

3 Axis

Model 45

MADE IN USA 

The Multi-Purpose Three Axis Series are highly flexible, making them ideal for a variety of manufacturing applications, wood, plastic sheets, nonferrous metals, aluminum, etc..

This system includes quality features seldom, if ever, found at this price point including full stress relieved weldments, high-end Siemens drives throughout, THK rails and three-dimensional volumetric position compensation, not available from anyone else in this market.

Thermwood CNC Machining Centers



Model 45
5' x 10' (1.5m x 3.0m) Table

Standard Features

- 12 HP (9 kw) HSD Spindle (3,000-24,000 RPM)
- Bar Style Automatic Tool Changer
- SuperControl
- Fixed High Flow Table with Moving Gantry
- Siemens Intelligent Servo Drives Throughout
- 3-D Laser Compensated Axis Alignment
- Control Networking
- Control Nesting
- Machine Training and Installation

Table Sizes Available

- 5' x 5' (1.2m x 2.4m) Table
- 5' x 10' (1.5m x 3.0m) Table
- 5' x 12' (1.5m x 3.6m) Table
- 6' x 12' (1.8m x 3.6m) Table
- 7' x 12' (2.1m x 3.6m) Table



THERMWOOD

Machining Plastic Sheets

Solid Surface Processing

Non-Ferrous Metals

Composites

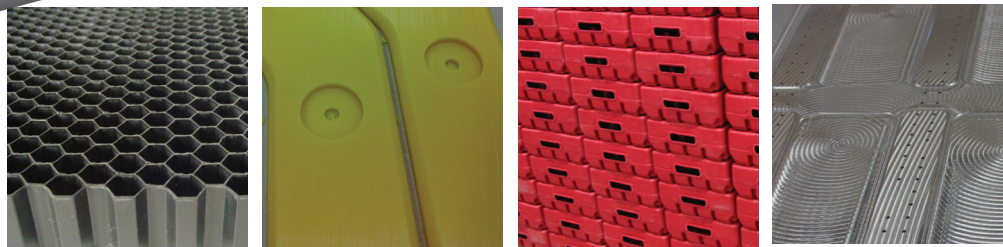

Model 45
7' x 12' (2.1m x 3.6m) Table
Optional At-the-Head
Typewriter Tool Changer

Machine Standard Features/Options



12 HP (9 kw) Spindle

A direct driven spindle with a speed range up to 24,000 RPM. The High Frequency Spindle is cooled with an electric fan for quieter running and contains ceramic bearings for longer life and for less maintenance. The 12 HP (9 kw) spindle provides the user with a heavy duty, precision spindle which provides high performance and reliability. **Standard**

18 HP (13 kw) Spindle

The 18 HP (13 kw) spindle (3,000 to 20,000 programmable RPM). Unit accepts HSK F63 toolholders, as well as Thermwood Aggregates and is equipped with an electric fan.

Bar Style Automatic Tool Changer

Mounts behind the rear of the table and hold the tapered tool holders. When the program calls for a tool change, the head moves back and places the tool into an empty space, it then moves over and picks up the appropriate tool, and then continues the program. **Standard**

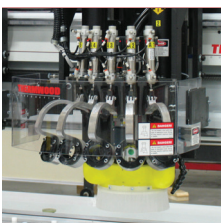
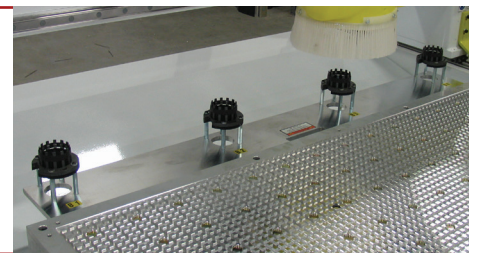

At-the-Head Tool Changer

This option consists of tool holder arms and five tool holders which mount in an arc around the front of the spindle and hold the tapered tool holders. When a program calls for a tool change the tool is automaticly changed at the head. Available for the primary head as well as an optional secondary head.

Machine Options Additional options available



2nd Head Spindle

A second head can be added to allow simultaneous machining of two parts. The second spindle includes a complete tool slide, second servo -controlled Z-Axis assembly and 24" (600mm) space bar. (Bar style tool changer can not be used with this option. At-the-Head Tool Changer is available for both heads.)

Automatic Lubrication

Provides positive pressure, air/oil lubrication to the linear trackway bearings and the ball screws. This has two major benefits. First, it eliminates the lubrication points which must be serviced each shift. Second, it provides positive pressure to the bearing preventing contamination from entering the bearing. This allows the machine to function in difficult, dusty or hostile environments.

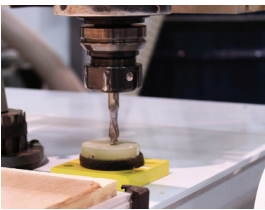
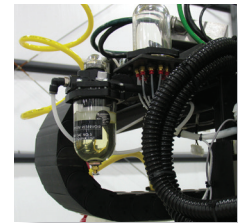

Automatic Tool Length Sensor

Provides an automatic method of measuring tool length and entering tool length offset numbers into the control. This automatically compensates for the new tool length eliminating the need to precisely locate the cutter bit. It provides a highly accurate method of adjusting tool length for pocketing or profile edges.

Aggregate Tooling

Aggregate tooling allows the operator to route or drill horizontally, and saw. While not in use, the aggregate tool body is stored in a tool holder located off the back of the table. Aggregate tooling adds a high level of machining flexibility.

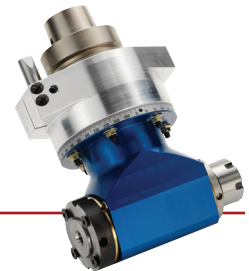

Drill Bank

The drill unit is vertical boring head with nine vertical spindles arranged in a right angle pattern with four arranged front to back and four left to right with one additional which is common to both. The spindles are on 32mm centers.

Rotary Playback

The rotational playback axis is attached to the top of the machine table. It is capable of accepting stock 8 inches (200mm) in diameter and up to 56" (1.4m) in length. The unit is designed primarily for reproducing furniture components.



Pop-Up Pins

Guides mounted to the table perimeter for locating sheets of material. They are flipped to the up position to locate the material and then retracted to clear during the machining cycle.

Vacuum Pump

Universal Vacuum System is a unique method for holding panels to the table top for machining. A sheet of particleboard or low density MDF is used as a work surface on the top of the table. The high flow pump vacuums through the work surface holding the part to the table. Pump 15 HP (11 kw). (Conventional also available)

SuperControl

Thermwood's SuperControl

Thermwood, the only major CNC router manufacturer that designs and builds its own CNC control, is a leader in implementing advanced control technology. The SuperControl incorporates more advanced control features than any other CNC control in the industry. And, because Thermwood provides all the technology, you have single source responsibility. Thermwood stands behind and supports the entire system and when new technology is available it can easily be upgraded.



Thermwood's SuperControl

- **Full Multi-tasking Control-** Uses Microsoft® Windows® 10 operating system, offering the ability to operate the machine and do other tasks on the control
- **Huge File storage-** 1 TB hard drive for storage and greater file execution with no delays.
- **Direct Link-** Accepts raw design files or CNC programs, compatible with virtually all design softwares.
- **Virtual Service-** Direct, live, visual contact to Thermwood's Service Department. (Optional)
- **Tool Management-** Keeps track of tool usage and automatically replaces it when needed
- **Maintenance Alerts-** Alerts you when lubrication or maintenance is needed.
- **Videos and Manuals-** Step by step how-to-videos to adjust, maintain and repair your machine. Electronic manual, with error reporting and dynamic 3-D assembly drawings with part numbers.

SuperControl Options Additional options available



Bar Code Input

This option includes a bar code which attaches to the side of the control cabinet. The bar code functions just like a key sequence from the keyboard. For example, the entire key sequence needed to load a program can be scanned as a bar code much faster that it can be typed, with little possibility of error. The bar code input system allows any commonly used key sequence to be printed or scanned.

Hand Held Programmer

Powerful tool for creating, modifying, editing and refining CNC programs at the machine. Programs can be debugged or created right at the machine. The machine moves right with the programming so you can see the exact position. Modifications can be made quickly, errors are minimized saving time.



Personal Pause Button

Thermwood has developed a remote wireless "Pause Button" which can be clipped to a belt or pocket. Pressing this button stops the machine in place.

CabinetShop 45

CNC Router Package for the Professional Cabinet Shops

- Packages combine all the elements needed to design and machine custom cabinets, closets, and furniture products.
- Thermwood CNC Routers are also compatible with most major CAD/CAM and design software.



CabinetShop 45
5' x 10' (1.5m x 3.0m) Table

Table Sizes Available

- 5' x 5' (1.2m x 2.4m) Table
- 5' x 10' (1.5m x 3.0m) Table
- 5' x 12' (1.5m x 3.6m) Table
- 6' x 12' (1.8m x 3.6m) Table
- 7' x 12' (2.1m x 3.6m) Table

Standard Features

- 12 HP (9 kw) HSD Spindle (3,000-24,000 RPM) with At-the-Head Typewriter Tool Changer (optional)
- SuperControl
- Fixed Flow Table with Moving Gantry
- Siemens Intelligent Servo Drives Throughout
- 3-D Laser Compensated Axis Alignment
- Control Networking
- Control Nesting
- Machine Training and Installation
- Automatic Lubrication (optional)

Package Features

- **Control Nesting** - A user friendly nesting package integrated into the Thermwood control to nest various parts into sheet stock, thus creating a better yield. Also, accepts layered DXF files.

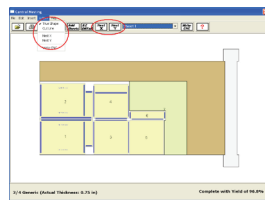

- **eCabinet Systems** - Sophisticated design software for cabinets, closets and furniture, that generates a CNC output file to be machined.



- **Color Coded Labels** - Prints a color bar on each label with a different color for each cabinet. This offers a significant productivity improvement.

Part:	Top 1
Cabinet:	Std Corner Framed-M OD1
Material:	3/4 Generic
Job:	assembly
EBanding:	None
Sheet #: 1	Part #: 1 Cabinet #: 1

- **Assembly Marks** - Machined assembly marks into each joint which define how parts mate. These marks are hidden once the parts are assembled.



- **Profile Modeler** - Creates modeling type tool path to produce profile edges with standard modeling tools.

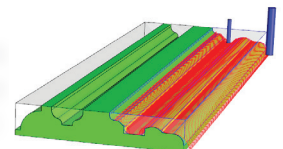

Software



Thermwood has a sales and support group that focuses on software products that work with and enhance the operation of Thermwood CNC routers. Their goal is to offer to Thermwood customers the most effective software products for their specific application, smoothly integrated with the control. You can be certain that software obtained from Thermwood will work properly with your Thermwood CNC router. (Thermwood machines can link with all major CAD/CAM softwares.)



Mastercam[®]



PANELMETRIX
MDF DOOR PRODUCTION SOFTWARE

Thermwood is your best source for software products for the following reasons:

- **Thermwood understands the application:** Thermwood knows how the package works with our machines.
- **We've solved the integration problems:** The package works from the software to the computer and then to the CNC control.
- **Our integrated training:** Thermwood offers training of the software and how it works with the control.
- **Thermwood software support:** Thermwood can provide support for the software package, the control and, most important the operation of the two together.
- **Multi-package integration:** Thermwood knows how to make them work together for your application
- **Professional evaluation:** When you purchase software from Thermwood you know that it was fully evaluated and it works.

Thermwood Technical Service

Thermwood's Technical Service offers a wide range of services for our customers to be comfortable and profitable with their CNC Router System. Each Thermwood CNC router system includes formal, structured training classes including professional support material and hands-on experience.

In addition to Thermwood's professional phone support and on-site service, we offer Virtual Service, which is an audio, video and data link from the machine controller and Thermwood's Service team. When the "Virtual Service" link is established, the customer can see and talk to the Thermwood service technician and the service technician can see, not only the customer, but also all of the critical parameters of the control. Through this link, the control can be diagnosed in real-time while programs are being executed and corrections can be made.

We also offer an On-line Supply Store, extensive Part Inventory, Custom Programming, an Advanced Support Program and a Retrofit and Upgrade Department.

Thermwood's training, "Virtual Service", continuing control updates, and free lifetime phone support offer you support like no one else and assures continuing profits from your Thermwood investment, years into the future.

Thermwood's Service

- Free Lifetime Phone Support
- Virtual Service
- On-site Technical Service
- Custom Programming
- Hands on Training Classes
- Professional Set-up
- On-line Supply Store
- Extensive Parts Inventory
- Retrofits and Upgrades
- Advanced Support



Dimensions

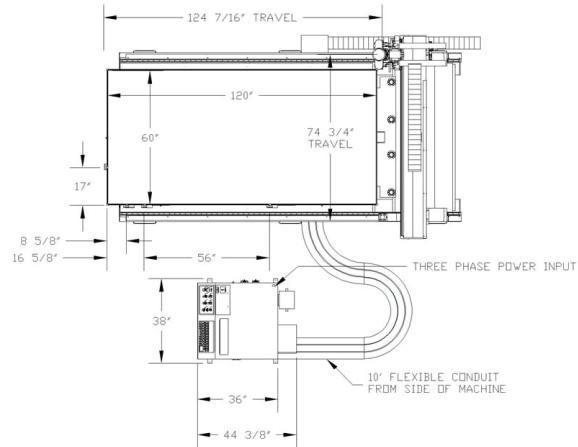
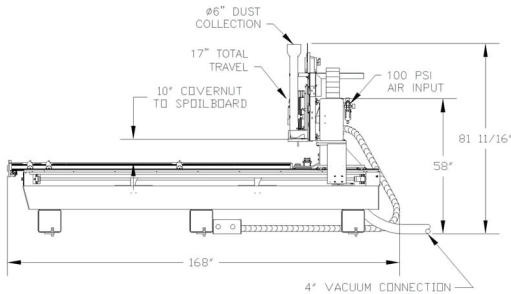
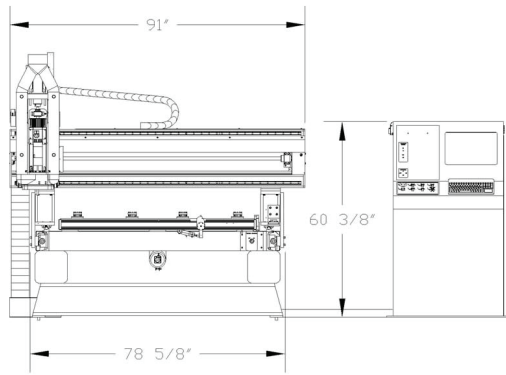

Model 45 Overall Dimensions (5' x 10' Table Shown)

- 5' x 5' Table: Height: 81" Width: 91" Length: 108"
(1.5m x 1.5 Table: Height: 2.0m Width: 2.3m Length: 2.7m)
 - 5' x 10' Table: Height: 81" Width: 91" Length: 168"
(1.5m x 3.0 Table: Height: 2.0m Width: 2.3m Length: 4.3m)
 - 5' x 12' Table: Height: 81" Width: 91" Length: 187"
(1.5m x 3.6 Table: Height: 2.0m Width: 2.3m Length: 4.7m)
 - 6' x 12' Table: Height: 81" Width: 103" Length: 187"
(1.8m x 3.6 Table: Height: 2.0m Width: 2.6m Length: 4.7m)
 - 7' x 12' Table: Height: 81" Width: 115" Length: 187"
(2.1m x 3.6 Table: Height: 2.0m Width: 3.0m Length: 4.7m)
- (Dimensions are approximate)

Thermwood...First in CNC Routers

Thermwood is the first company that developed and manufactured CNC router technology in the US. Starting in the late 60's, Thermwood continues to offer products and software technology for the wood, plastics and aerospace industries, involving numerous areas of machining applications.



The main facility consists of 175,000 square feet which includes both an office/showroom and an engineering and manufacturing plant. Manufacturing utilizes modern fabricating, machining, assembling and testing processes from the machine fabrication to the CNC control production.

www.thermwood.com

Thermwood is an International company that strives in technology, software, support and service to best fit the needs of our customers. Thermwood...the first in CNC routers.



THERMWOOD



P.O. Box 436, Dale, IN 47523
 Phone: 800-533-6901,
 812-937-4476,
 Fax: 812-937-7053